



Operation Manual

Temperature Controller

Series W-700



W-710



W-720



W-730

Table of contents

1	Safety information.....	4
1.1	Place of installation of the unit	4
1.2	Instructions for installation	5
2	General information	6
3	Putting into operation	6
3.1	Wiring	6
3.2	Switching on	6
3.3	Setup.....	7
4	Control elements.....	8
4.1	Overview of functions	8
4.2	Standard display information.....	8
4.3	Status LED.....	9
4.4	Error detection and display	9
5	Schematic and mode of operation.....	10
6	Operation and settings.....	11
6.1	Specifying the setpoint.....	11
7	Settings via the menu.....	11
7.1	Menu structure.....	12
8	Menu items	12
8.1	Controller type	12
8.2	Controller setup.....	13
8.3	Limiter type	14
8.4	Limiter setup.....	14
8.5	Sensor A / sensor B.....	14
8.6	Output	15
8.7	Timer	15
8.8	Unit	15
8.9	Language	15
8.10	Advanced.....	15
8.11	Power-on behaviour.....	15
8.12	Stop on error	15
8.13	Heater check.....	16
8.14	Signal output	16

8.15	Password protection	16
8.16	Factory defaults.....	16
8.17	System info	17
9	Optional communication module	17
9.1	Communication module additional menu (optional).....	17
9.2	Communication module settings (optional).....	17
10	Controller on / off.....	18
11	Application examples	19
11.1	Simple controller operation with one sensor.....	19
12	Troubleshooting	20
13	Terminal assignment	21
14	Standard pin assignments	22
15	Repair and maintenance	23
16	Disassembly and disposal.....	23
17	Drilling template.....	24
18	EU Declaration of Conformity	25

1 Safety information



Before putting the unit into operation, you must read and ensure compliance with the safety information, installation instructions and operating manual supplied with the unit.

Please read the safety information carefully and ensure compliance with the instructions, otherwise the safety of personnel and equipment may be impaired. The unit is predominantly designed as a temperature controller for electrical heating systems. Improper use, installation, configuration or operation may cause severe personal injury and extensive damage to property!



Important: This unit is not a safety temperature limiter to DIN EN 60730-1!

The unit must not be installed in potentially explosive atmospheres. If a process function originating from an explosion-risk area is to be processed by the unit, which is installed outside the explosion-risk area, all supply lines of the unit leading into the explosion-risk area must be installed using approved safety barriers!

Error-free and safe operation of the unit requires its careful transportation and storage, as well as correct assembly and installation. This unit may only be installed, configured, parameterised and commissioned by qualified persons who are familiar with the installation, commissioning and maintenance of comparable devices and with the system in which the unit will be used and who have appropriate knowledge in the field of instrumentation and control. Operating staff of the system in which the unit is to be used must be instructed by suitably qualified persons on operation and control of the unit.

Please observe and comply with:

- The contents of the present manual regarding installation and operation of the unit, in particular the information on installation and putting into operation and any notes in bold print.
- Any safety information attached to the unit.
- Any relevant safety regulations for installation and operation of electrical systems.
- Safe storage of this manual for future use.

The regulations stated in the present manual are applicable in all EU countries. If the unit is to be used in a country outside the EU, ensure compliance with the relevant national rules and regulations.

This unit has been manufactured and tested in accordance with DIN EN 61010 Part 1 “Safety requirements for electrical equipment for measurement, control and laboratory use” and has left our company in an error-free condition in terms of its safety and functionality.

1.1 Place of installation of the unit

The unit is designed as a temperature controller for flexible application in electrical heating systems. The place of operation or installation of the temperature controller must not be close to motors, transformers, circuit breakers or other inductive loads; it must be installed in a vibration-free location. The ambient temperature at the place of installation must be between -20 °C and 50 °C . Aggressive gases and vapours may damage the unit.

1.2 Instructions for installation

Please read the installation instructions carefully and comply with all points mentioned in them when installing the unit. Non-compliance with these instructions for installation may result in faults or malfunctions or the unit may fail to comply with the required EMC guidelines and thus the conditions for CE-conformity will not be fulfilled.

Before connecting the unit and putting it into operation, please ensure that the operating voltage and the conditions for the operating voltage required by the unit correspond to the conditions on site (see name plate and technical data). If required, take any appropriate measures.

Please ensure that the control and load voltage on site are switched off and secured against accidental reactivation during installation of the unit. The electrical connections must be in accordance with relevant national rules and regulations. The supply lines for the device must be installed such that they are free from any tensile loads and are not exposed to risks of shearing or crushing under any circumstances.

The mains connection and the connections for consumers must each be provided by suitable cables with a cross-section of at least 1.5 mm².

For sensor lines and signal lines, the use of shielded cables is strongly recommended (especially if lines are long and/or running along potential sources of interference); for thermocouples, shielded compensation lines should also be used. Sensor lines and signal lines should be installed such that they are spatially separated from the load and control lines (high-voltage lines). If signs of incorrect switching behaviour are detected, the system must be put out of operation until the cause is eliminated.

Normal terminals may not be used for intermediate clamping of compensation lines for thermocouples since this would result in the creation of additional thermocouples that could falsify the measurements.

The controller is designed for the switching of ohmic heating units. Any inductive loads activated by the unit, such as contactors, valves, motors, transformers, etc. must be wired separately and provided with unit-specific suppression devices.

When connected to the "Line 10A Fuse int." terminal or type W-720 / W-730, the load circuit is protected against overcurrent with an internal 5x20mm 10AT fine-wire fuse. When connected to the "Line unfused" terminal, the load circuit must be protected against overcurrent with a suitable fuse by the customer.

The present manual does not contain an exhaustive list of all regulations, standards, etc. that must be observed and complied with when using the unit in combination with other systems and plant. Any such regulations, standards, etc. shall be complied with and observed by the operator of the unit with regard to the specific application.

2 General information

The W-700 temperature controller series offers a wide range of features, intuitive functions and an extremely long service life. The FAT (fast adaptive tuning) algorithm continually adjusts to the control loop thus ensuring precise control. The setting of PID parameters and the execution of an autotuning procedure are not required. All functions can be quickly accessed and changed in the plain-text menu. The integrated hybrid relay system ensures a long service life with low losses in the controller. The additionally installed cut-off relay minimises the risk of damage should the hybrid relay fail. The self-optimising FAT control algorithm makes sure that the target temperature is reached quickly while avoiding overshoots. The two independent universal sensor inputs allow easy connection of a variety of common resistance temperature sensors as well as thermocouples. The limiter module provides additional protection and flexibility in the control strategy. The electronics are protected against overcurrent and overheating.

The multi-colour LED provides highly visible, simple signalling of the various operating modes.

3 Putting into operation

The unit comes supplied with standard parameters. This configuration matches the specific requirements in very few cases. This means that the unit must be adjusted to the desired temperature limits of the application and the type of sensor used.

3.1 Wiring

If the unit is supplied ready for connection with plug-in connectors, please ensure the correct pin assignment of the connectors. All cables used must comply with the relevant current and voltage requirements.

In the case of units for connection by the user, the front panel must be removed in order to access the internal terminals. To do this, open the cover and remove the 4 Phillips screws (PH1). If necessary, remove the front panel from the housing by gently shaking it or pushing the mains cable.

To begin wiring, place the front module next to the enclosure on a non-slip surface. Or if the enclosure is already wall-mounted, the front module can be clamped under the spacer bolts.

All spring-loaded terminals can be easily activated using a flat-blade screwdriver. For a description of the terminals, see section 13 Terminal assignment on page 21.

3.2 Switching on



Check the wiring again carefully!

Incorrect wiring of the unit can cause serious damage to the unit and the system! Make sure that the load voltage of the system is switched off when you switch on the unit for the first time as the unit has not yet been adjusted to the system and may under certain circumstances trigger malfunctions.

Now switch on the operating voltage of the unit.

3.3 Setup

Go to the settings menu and select the desired values for controller type, limiter type, setpoint, upper limit and lower limit and good range (value corridor) as well as the limit temperature for monitor or limiter. Configure the temperature sensor used. See section 7 Settings on page 11

4 Control elements

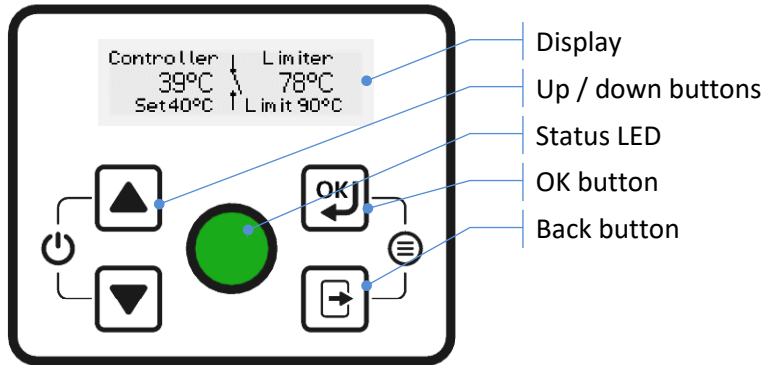

4.1 Overview of functions

- Open menu: Press and back simultaneously
- Change setpoint: Press and hold up or down
- Acknowledge error: Pressing deletes the error if it has been rectified.
- Controller on / off: Press and hold up and down buttons at the same time

4.2 Standard display information

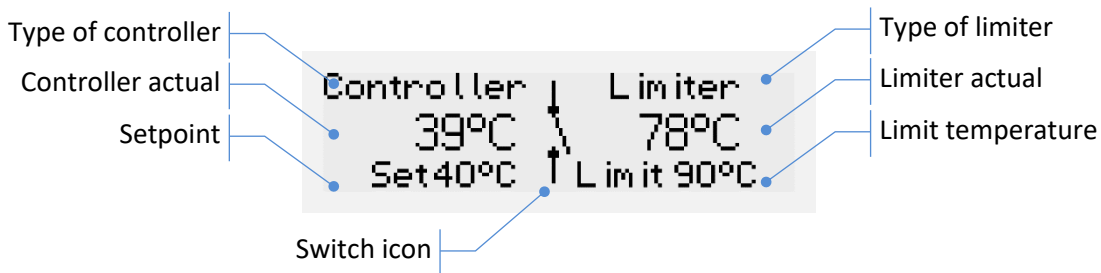

- Type of controller: Displays the currently selected type of control
- Setpoint: Temperature setting to be maintained by the controller
- Controller actual value: Current temperature measured by the controller sensor
- Switch icon: Displays whether the output is currently switched on
- Type of limiter: Displays the currently selected type of limiter
- Limiter actual value: Current temperature measured by the limiter sensor
- Limit temperature: Temperature setting that should not be exceeded by the limiter

4.3 Status LED

Switching on:



After switching on, the controller starts with a self-test and displays a white LED. If everything is OK, the LED lights up green briefly and the controller starts up. If an error is detected an error signal will be displayed. See 4.4 Error detection and display

Temperature display

At setpoint temperature the display LED is permanently green. If the temperature is too low, the display flashes blue slowly (1 Hz). If the temperature is too high, the display flashes red slowly:

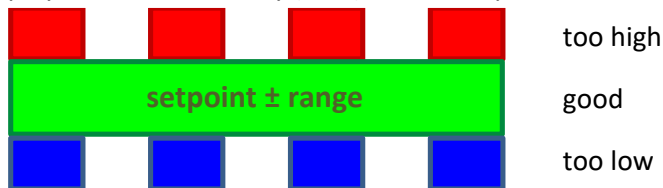

Limiter:



If the current temperature of the limiter sensor exceeds the set limit temperature, the status LED flashes yellow slowly.

4.4 Error detection and display

When switching on and during operation the controller checks the following error statuses:

1. PCB temperature
2. Power supply
3. Sensor interruption
4. Relay failure



LED signal on error

If an error occurs, the heating is switched off and the error is indicated by rapid flashing at 4 Hz:

1. Unit error:  4 Hz
2. Sensor error: 

Display on error

In addition, the error message is shown in plain text on the display.

Errors can be acknowledged with the  button. Pressing  and  at the same time takes you to the menu (e.g. to change sensor type).

If the error condition is rectified, the controller switches back to normal operation. Otherwise, the unit must be disconnected from the mains.

Please see also section 12 Troubleshooting on page 20

5 Schematic and mode of operation

The unit has two independent sensor inputs, each of which can be used for the control function and/or limiting function. The control function tries to reach the set temperature quickly and to maintain it. The limiting function monitors the temperature to see if it exceeds the limit temperature and to shut down if this is the case. The output then controls heating or cooling.

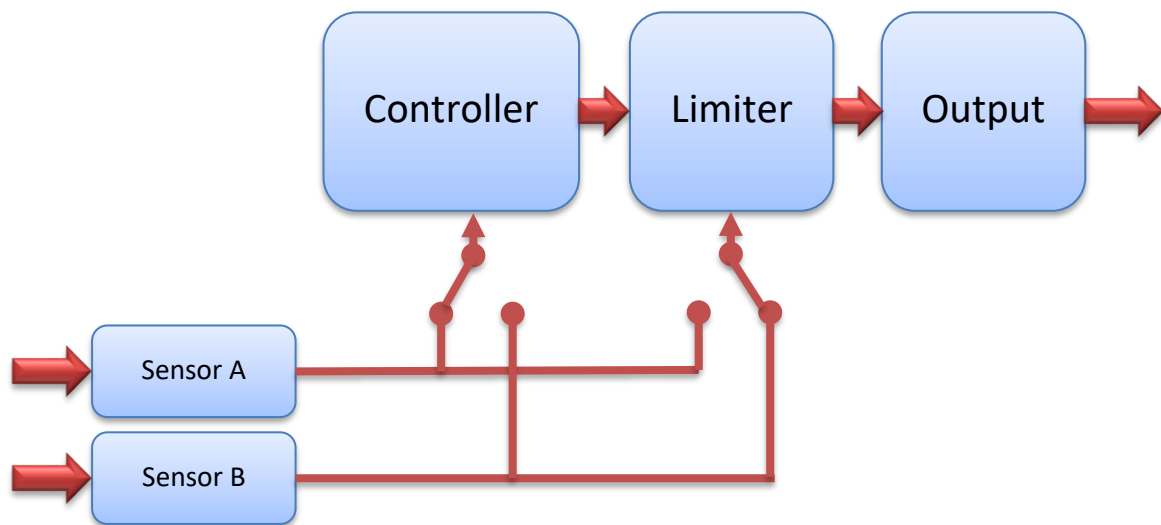

6 Operation and settings

6.1 Specifying the setpoint

From normal mode, you can adjust the setpoint by pressing and holding the ▲, ▼ or  buttons.

Display:





Use the ▲ / ▼ buttons to select the desired setpoint within the upper and lower limits. These can also be changed separately in the menu (see section 8.2.2, page 13).

 button: Accepts the value

 button: Cancels the process, setpoint remains unchanged

7 Settings via the menu

Pressing  and  simultaneously takes you to the menu where all unit settings can be specified.

Display:

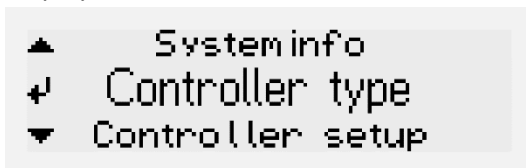

Press ▲ and ▼ to navigate through the menu.

Use the  button to open the selected menu item.

Use the  button to quit the menu item.

7.1 Menu structure

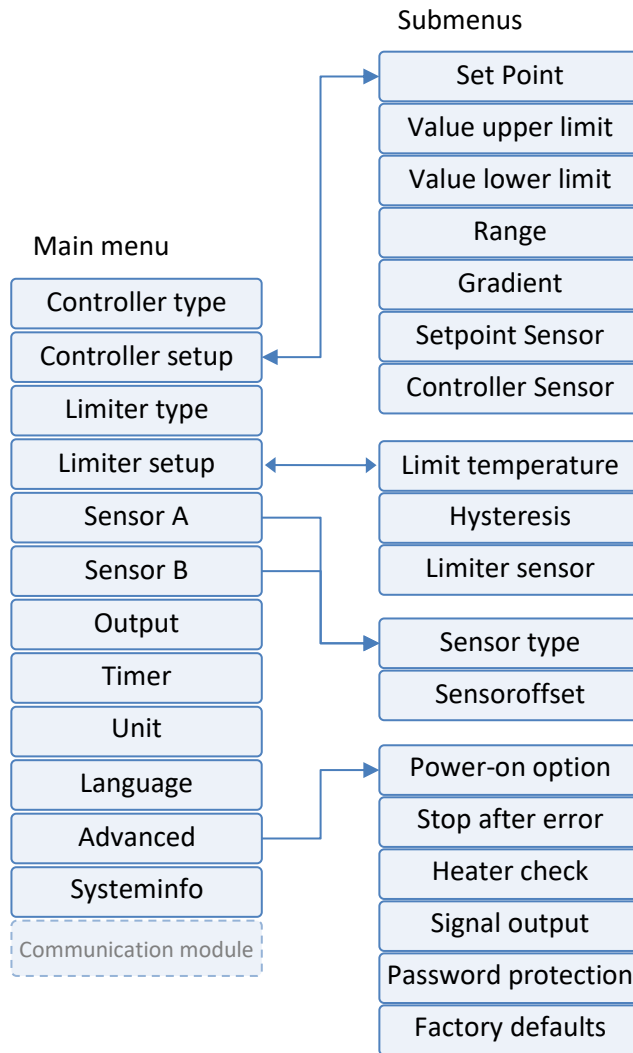

8 Menu items

8.1 Controller type

Here you can select how the controller tries to control the temperature.

- **FAT controller:** Fast Adaptive Tuning is a self-adjusting control algorithm developed by Winkler itself. The controller continuously monitors the temperature changes that occur during heating or cooling, how high the overshoots or undershoots are, and then adjusts the switching points to obtain an optimum control result. The specified good range is used in this process and may save on switching cycles. This also increases the service life.

- **2-point controller:** Classic control method with two switching points. Upper switching point is setpoint + ½ good range, lower switching point is setpoint - ½ good range.
- **Fixed output:** Emergency mode to manually control heating or cooling. Can be used to protect the medium in the event of sensor failure until spare parts are available. Based on the set percentage value, the output is switched on and off again proportionally within one minute. (25% -> 15s on, 45s off).
- **Deactivated:** No temperature control takes place, the output is influenced only by the limiter. The temperature sensor for the controller functions solely as a temperature indicator.

8.2 Controller setup

Here you'll find all settings for controller setup.

8.2.1 Setpoint

See 6.1 Specifying the setpoint

8.2.2 Value upper limit / lower limit

The relevant process limits are set here.

When specifying the setpoint, only values within these limits can be entered. This prevents a value that is too high or too low being set accidentally. The upper limit and lower limit can be adjusted according to the selected sensor type.

8.2.3 Range

If the actual temperature is within the set good range, the status LED is permanently green.

In this menu item, a range of between ± 0.5 °C and ± 20 °C can be set. The step size is 0.1 °C.

The larger the value selected, the less frequently the heating is switched on and off. With this function you can either maintain a more accurate temperature or increase the life of the switching element. (Factory default setting: ± 3 °C)

In the case of heaters that tend to overshoot strongly, it can be useful to select as wide a good range as possible (provided this tolerance is permitted in the process), so that the controller only switches on at lower temperatures. In this way, fluctuations remain within the good range.

8.2.4 Gradient (ramp)

This specifies the average gradient with which the current temperature should approach the setpoint. This prevents over-rapid heating or cooling for sensitive media or processes.

8.2.5 Setpoint Sensor

If follower control is activated, the second sensor input is used as the setpoint. For example, if sensor A is set as the sensor for the controller, the current temperature of sensor B is used as the control setpoint. This can be useful if you want to measure the temperature of an already heated object (e.g. container) and to control the same temperature for a different location (e.g. supply line).

8.2.6 Sensor – control

Indicates which sensor input is used for control.



ATTENTION: It is permissible to use the same sensor input for both the control and limiting functions, please check your application to see which configuration makes sense.

8.3 Limiter type

This setting determines how the system should respond when the limit temperature is exceeded

- **Temperature monitor:** This switches off the system when the limit temperature is exceeded. As soon as the temperature falls below the limit temperature minus hysteresis, the controller takes over again.
- **Temperature limiter:** This shuts down the system permanently when the limit temperature is exceeded. The controller only takes over again when the  button is pressed and the temperature is below the limit temperature minus hysteresis.
- **Delta temperature:** The limit temperature is always a fixed amount above the current controller actual temperature.
- **Deactivated**

8.4 Limiter setup

8.4.1 Limit temperature

Defines the temperature at which the output is shut down.

8.4.2 Hysteresis

Here you can set how far the temperature must be from the limit temperature before the monitor switches on again automatically or before the limiter can be acknowledged.

For instance, with 5°C hysteresis and 100°C limit temperature, the temperature must fall below 95°C before it can be switched on again.

8.4.3 Limiter sensor

Indicates which sensor input is used for the limiter.



ATTENTION: It is permissible to use the same sensor input for both the control and limiting functions, please check your application to see which configuration makes sense.

8.5 Sensor A / sensor B

In this submenu, you can specify the settings for sensor input A or B

8.5.1 Sensor type

Here you can select the connected sensor from the list of sensor types.

8.5.2 Sensor offset

With this option, an offset can be added to or subtracted from the measured actual value. This allows an offset adjustment to be made using an external temperature reference measurement to compensate for any measurement deviations due to the sensor element, sensor position or line

resistance.
(Factory default setting: 0.0 °C)

8.6 Output

Here you can select whether a heating or a cooling unit is connected to the controller.

- Heater: The output is enabled when the controller attempts to increase the temperature.
- Cooler: The output is enabled when the controller attempts to decrease the temperature.

8.7 Timer

Can be used to switch off the controller after a certain time. When the controller is switched on, this timer is inactive and must be started manually if required.

8.7.1 Timeout

Specifies how long the controller should continue to run after the timer has started.

8.7.2 Start

Starts the timer. The remaining time until switch-off is shown in the status display. After the time has elapsed, the controller switches off.

8.8 Unit

Selects the physical temperature units: Celsius (factory default) or Fahrenheit.



8.9 Language

Languages available: German (factory default), English, Spanish and French. (Note: The language menu and the languages are always also labeled in English.)

8.10 Advanced

8.11 Power-on option

This option defines the behaviour of the controller after switching on the power supply. The following options are available:

- Always power on (factory default): Ensures that the controller starts as soon as there is a connection to the mains supply.
- Stay off: After connecting the mains supply, the controller must be manually switched on using the  and  buttons.
- Last state: The controller changes to the last state before power-off.

8.12 Stop after error

When this option is activated (factory default), the controller stops whenever an error is detected and displays it permanently. The control process is discontinued.

If this option is deactivated, the controller automatically tries to resume operation as soon as the error situation has been remedied.

8.13 Heater check

If this function is activated (factory default), the controller checks whether a heater is connected. If the controller detects an interruption, it displays an error message. Detection requires a minimum of 10 W. If no check is desired, e.g. because only a contactor or SSR rather than a heater is connected, the function can be deactivated.





8.14 Signal output

The signal output can be used for signalling to a control system or for switching signal lamps or similar elements. You can choose when the signal output is activated:

- Setpoint reached (factory default): The signal output is activated as soon as the actual temperature of the controller is within the good range (as soon as the status light also lights up green). See also 8.2.3 Range on page 13
- Limiter active: The signal output is activated as soon as the actual temperature of the limiter/monitor sensor is above the limit temperature. Once the temperature falls again below the limit temperature minus hysteresis, the signal output switches off.
- Temperature alarm: If this option is selected, two further temperature values are retrieved – firstly over-temperature, then under-temperature. If the actual temperature of the controller exceeds the over-temperature or is below the under-temperature, the signal output is activated. If the temperature is between the two values, the signal output is deactivated.
- Errorstate: The signal output is activated as soon as an error is detected and an error message is displayed.
- Heater active: The signal output is activated when heating is active.

8.15 Password protection

If this option is activated, a 4-digit password is requested. This code is requested when the user wants to access the menu. The setpoint can still be adjusted from normal operating mode (see section 6.1 on page 11). To prevent the user from changing the setpoint, please set the upper limit and lower limit parameters to the same value as the setpoint (see 8.2.2 page 13). This stops the setpoint from being changed when the user is in normal operating mode.

To enter the password, change the currently active digit using the  and  buttons and confirm with . The cursor then moves to the next digit. Once the complete password is entered, it is displayed and must be confirmed once more with . Please make sure you remember the password or note it down in a secure place. The process can be cancelled at any time with . The previous settings then remain active.

If you have lost the password, please contact our Service Department at service@winkler.org. For your own security, the issue of the factory-reset password will be recorded at our Service Department. We will only provide the factory-reset password after receiving your full name, email and phone number.

8.16 Factory defaults

This can be used to reset the factory default settings and start with a fresh configuration.



ATTENTION: If you select "Yes" here and confirm with , all existing settings will be lost. Even pre-parameterised units will lose their original configuration.

8.17 System info

Gives information about the unit, including firmware and hardware version.

9 Optional communication module

The controller can optionally be fitted with a communication module.

9.1 Communication module additional menu (optional)

If the communication module is fitted, a further menu level is available for configuring the module

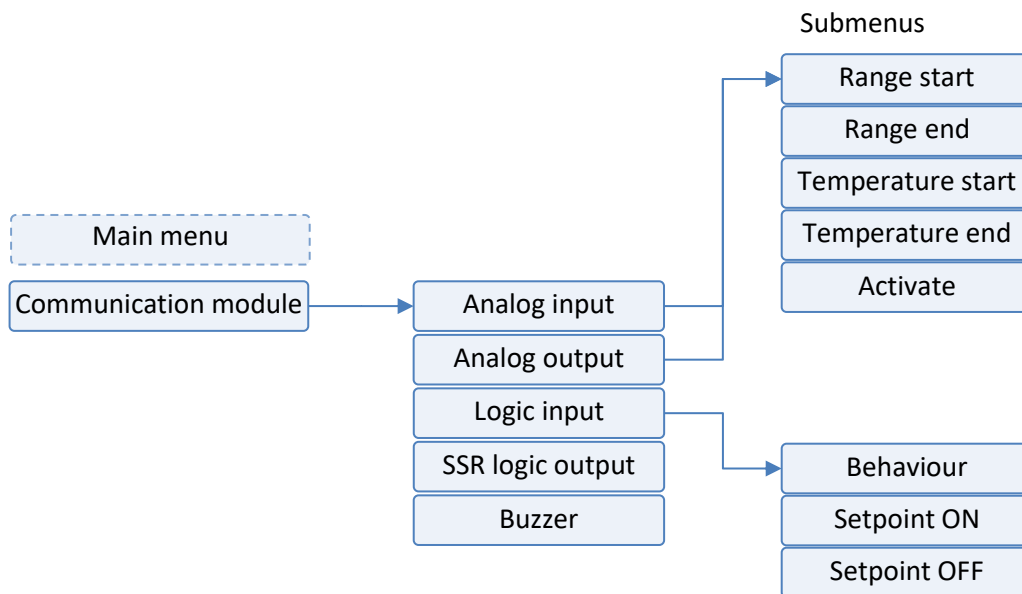

9.2 Communication module settings (optional)

9.2.1 Analog input (optional)

The analog input enables a setpoint to be specified for the controller. The setpoint is specified in accordance with the value of the analog signal.



ATTENTION: Note the switch position on the communication module: A slide switch on the module lets you choose between a current signal (20mA) and a voltage signal (10V).

Range start and Range end indicate the start point and end point of the analog signal. For example, if using a 4-20mA current signal, start = 20% = 4mA and end = 100% = 20mA. If using a 0-10V voltage signal, start = 0% and end = 100% = 10V.

In addition, a temperature can be set for the start and end.

To use the analog signal for the setpoint, select "Yes" under "Activate".

9.2.2 Analog output (optional)

The analog output enables feedback of the currently measured temperature value of the controller to a higher-level control system. An analog value is output via the analog interface in accordance with the measured temperature.



Attention: Note the switch position on the communication module: A slide switch on the module lets you choose between a current signal (20mA) and a voltage signal (10V).

Range start and Range end indicate the start point and end point of the analog signal. For example, if using a 4-20mA current signal, start = 20% = 4mA and end = 100% = 20mA. If using a 0-10V voltage signal, start = 0% and end = 100% = 10V.

In addition, a temperature can be set for the start and end.

To use the analog signal for the setpoint, select "Yes" under "Activate".

9.2.3 Logic input (optional)

A signal can be sent to the controller via a potential-free switch such as a relay or a button.

Under "Behaviour", you can select which function this should trigger.

- Limiter reset: If the limiter has been configured and the limit temperature is exceeded, the limiter can be acknowledged via the contact. Once the contact is closed (pulse > 1s) and the temperature of the limiter has fallen below the limit temperature minus hysteresis again, the control process is restarted.
- Controller enable: Controller is only active as long as the contact is closed. If the contact is open, the controller switches to the pause state and the output is deactivated (no cooling or heating).

9.2.4 SSR logic output (optional)

A solid state relay with DC switching input can be connected to the SSR logic output. The output is switched to 15V and internal resistance 100 Ohm. (Output is temporarily short-circuit proof)



9.2.5 Buzzer (optional)

The unit has an acoustic signal generator that sounds in various operating states. You can select from the following behaviours:

- Fault: As soon as a fault is detected by the unit, an alternating acoustic signal is emitted.
- Limiter active: In monitor or limiter mode, an alternating acoustic signal is emitted for as long as the limit temperature is exceeded or until the limiter is acknowledged.



10 Controller on / off

Depending on the selected power-on behaviour (see section 8.11 Power-on on page 15), the controller starts after the mains voltage is applied or remains in standby.

The controller can be switched to standby or switched on again by pressing and holding the  and  buttons simultaneously.

11 Application examples





11.1 Simple controller operation with one sensor

- Place the desired sensor as close as possible to the location that is to be kept at a desired temperature.
- Make sure that the heater is intrinsically safe or cannot overheat during operation, or that suitable temperature protection is built into the heater.
- Press  and  together to switch to the menu.
- Under type of limiter, select "Deactivated".
- Under "Type of Controller", select the desired control type. In most cases, "FAT controller" is the preferred option as in this case the controller adapts itself to the control loop. For particularly sluggish heaters (heating process lasting several hours or heater that does not tend to overshoot), a 2-point control algorithm can also be used.
- Controller setup submenu
 - Set the upper and lower limits to the desired maximum and minimum adjustable setpoints. (This ensures that the setpoint cannot be set too high or too low during operation or when password protected).
 - Set the desired setpoint
 - Set the permissible good range. The value selected should be as large as possible. This gives the controller more leeway to adjust the switching points. The smaller the value selected, the more strictly the controller tries to maintain the temperature.
 - Setting a gradient is only necessary if the temperature must always change at a certain speed, otherwise set gradient to "Off" (press and hold )
 - Deactivate follower control
 - With sensor control, select the sensor connection used
- Set the desired sensor type in the sensor connection menu (sensor A or sensor B).
- All done! The controller should now regulate to the set temperature.

12 Troubleshooting

Error:

Actions:

Display stays dark	<ul style="list-style-type: none"> • Check power supply. • Press  and  for a few seconds to power on. • Disconnect and reconnect unit from mains supply. • Check internal wiring • Contact Service Department.
Message "Sensor error!"	<ul style="list-style-type: none"> • Press  and  together to switch to the menu and check sensor settings. (Is the correct sensor type selected?) • Check wiring for short circuit or wire breaks, check connection in terminal / plug. • Check resistance value of sensor. • If necessary, replace sensor.
Message "Unit overheated!"	<ul style="list-style-type: none"> • Press  to acknowledge error or disconnect unit from mains supply and let it cool down. Then reconnect. • Check correct connection in terminals for mains supply and heater connection. • Provide better air circulation. • Check current in heater circuit.
Message "Mains supply error!"	<ul style="list-style-type: none"> • Disconnect and reconnect unit from mains supply. • Is stable 50 Hz or 60 Hz available? • Switch off sources of interference such as large motors or power converters. • Install suitable interference suppression measures. • Is it being used on mobile power generator? Check voltage and frequency are correct. Choose suitable supply. Test on local power grid. Does the message still appear? Contact Service Department.
Message "System error!"	<ul style="list-style-type: none"> • Disconnect and reconnect unit from mains supply. • Is the message still there? Contact Service Department. • Has the message disappeared? Check all settings and adjust if necessary.
Message "Heater/switch defective!"	<ul style="list-style-type: none"> • Check heater circuit wiring. • Check heater for short circuit or outage. • Power of heater too low? <10 W? • Disconnect and reconnect unit from mains supply. • Under Advanced -> Switch off heating circuit monitoring • Error message still appears? Contact Service Department.
Message "Switch defective!"	<ul style="list-style-type: none"> • Cutoff relay malfunction. • Disconnect and reconnect unit from mains supply. Error message still appears? Contact Service Department.
Lost password	<ul style="list-style-type: none"> • See section 8.14, page 16

Contact Service Department at service@winkler.org

13 Terminal assignment

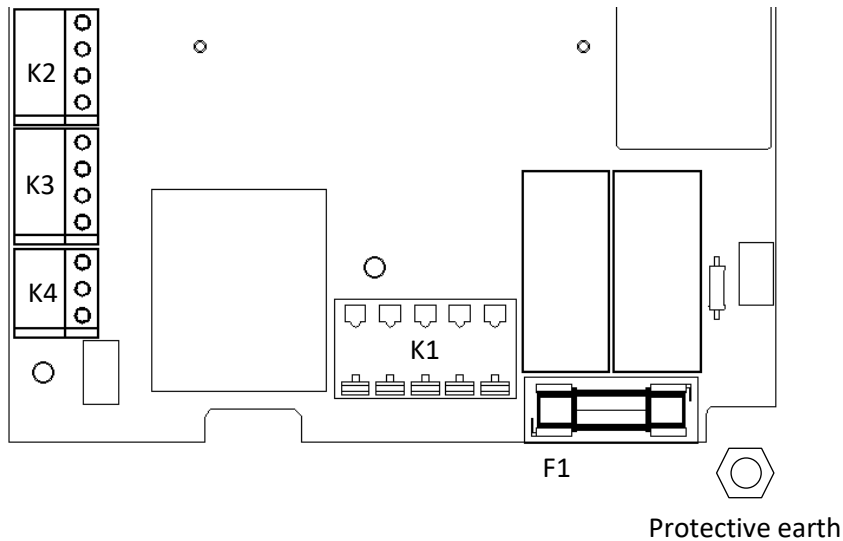

K1: Power supply and heating unit connection (flexible or rigid conductor up to 2²mm):



- Terminal line unfused: Supply line phase for heaters with currents greater than 10 A or more than 2300 W at 230 V AC / 1100 W at 110 V AC. **Here, the line protection must be ensured by an external protective device / fuse!**
- Terminal line 10 A fuse int.: Supply line phase for heaters with currents up to 10 A or up to 2300 W at 230 V AC / 1100 W at 110 V AC. The internal fuse F1 is used here for the heating current.
- Terminal N: Neutral conductor for supply line
- Terminal N Heat: Neutral conductor for heating
- Terminal L Heat: Phase conductor for heating

K2: Connection for sensor B (flexible or rigid conductor up to 1.3²mm). **With thermocouples, check for correct polarity!**

K3: Connection for sensor A (flexible or rigid conductor up to 1.3²mm). **With thermocouples, check for correct polarity!**

- With 2-conductor connector, terminals 1 (thermocouple -) and 2 (thermocouple +) must be used.
- With 3-conductor connector, terminals 1, 2 and 3 must be used.
- With 4-conductor connector, terminals 1, 2, 3 and 4 must be used.

Resistance sensor connection diagram for terminals K2 / K3:



Thermocouple sensor connection diagram for terminals K2 / K3:

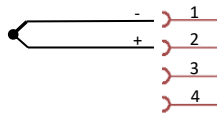

K4: Signal output for external monitoring/control (flexible or rigid conductor up to 1.3²mm).
Potential-free switch

F1: 5x20mm fuse for heating current (maximum 10A T)

PE connection (M4): The protective earth conductor of the supply line and of the heater are connected to this thread with the ring cable lugs supplied.

14 Standard pin assignments

(Other pin assignments available on request)

Amphenol ecomate C016 6+PE

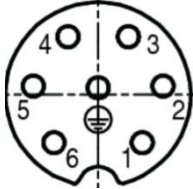

Heating circuit (max. 10 A) is fused via internal microfuse.

Pin	Function
1	L Heater
2	N Heater
3	Sensor B (+)
4	Sensor B (-)
5	Sensor A (+)
6	Sensor A (-)
Protective earth	connection

*(IEC 60751)

Junction box 10+PE

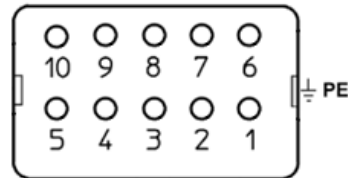

Heating circuit (max. 16 A) must be protected by an external fuse (e.g. circuit breaker of the supply line)

Pin	Function
1	N Heater
6	L Heater
2	Sensor A (+)
7	Sensor A (-)
3, 4, 5	Sensor B (+)
8, 9, 10	Sensor B (-)
Protective earth	connection

15 Repair and maintenance

If the controller is damaged, please return the controller to us with a description of the problem.

Maintenance intervals and maintenance requirements according to DGVU Rule 3 apply.

If the unit becomes dirty, turn power off, and clean with a damp cloth. Heavy dirt may be cleaned with a non-abrasive, solvent-free cleaning agent.

16 Disassembly and disposal



The unit may only be disassembled when it is switched off and safely disconnected from the mains.



Electronic devices are recyclables and should not be put in the household waste. Dispose of the product at the end of its service life in accordance with the applicable legislation.

17 Drilling template



Important: Leave a space of at least 50 mm around the unit for easy lid operation and air circulation.

After printing the template, check the scale for correct drill hole positions.

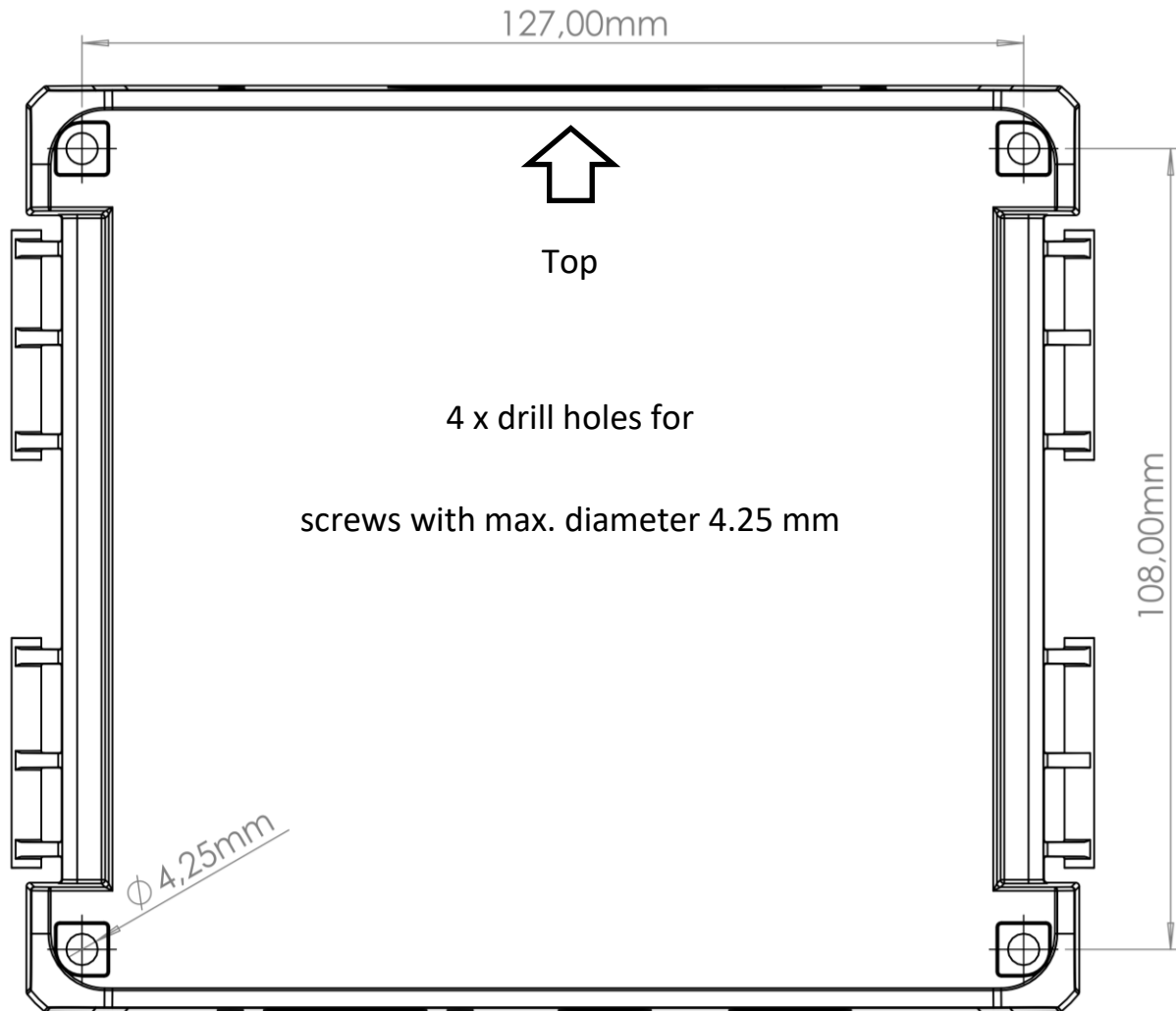

Check print scale 1:1

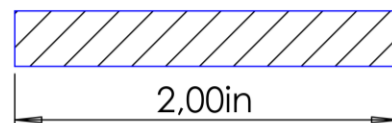
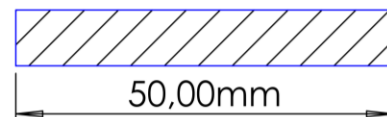

18 EU Declaration of Conformity

EU-DECLARATION OF CONFORMITY

winkler



Manufacturer: Winkler AG
Englerstr. 24
69126 Heidelberg

Contact: Tel.: +49 6221 3646-0
Fax.: +49 6221 3646-40
sales@winkler.eu
www.winkler.eu

Product group: Temperature controllers

Series / item: **Series W-700 / WRW7...**

Directives: Directive 2014/35/EU Low Voltage Directive
Directive 2014/30/EU Electromagnetic Compatibility
Directive 2011/65/EU restriction of the use of certain hazardous
substances in electrical and electronic
equipment
Directive 2017/2102/EU amending Directive 2011/65/EU

We hereby declare that in planning and manufacturing of this product the basic safety and health requirements of the EU Directives mentioned above have been observed.

Further rules and technical specifications applied:

EMC requirements: EN 61326-1:2013
Emission: EN 61000-6-4: 2020-09
Immunity: EN 61000-6-2: 2019-11
Safety requirements: EN 61010-1: 2020-03

Any modification to the product without our consent will make this declaration invalid.

Heidelberg, March 28th, 2022

Winkler AG

A blue ink signature of CEO A. Zenner, consisting of a series of loops and a final upward stroke.

CEO A. Zenner